

UVVIT

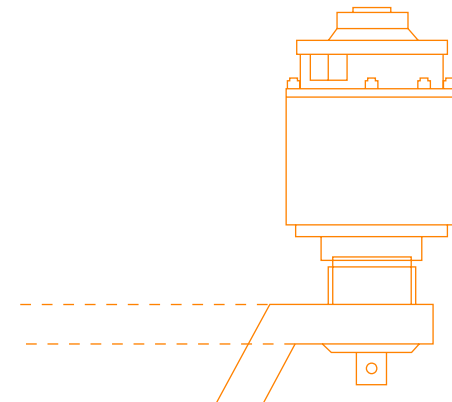

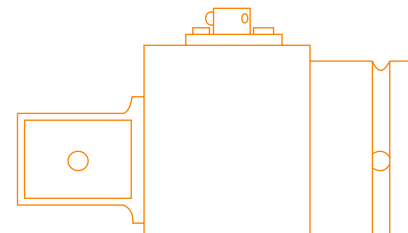

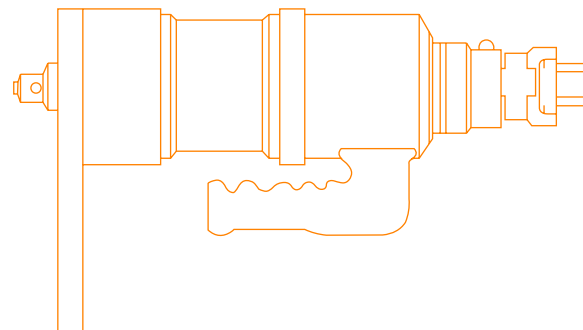











La guida del **SERRAGGIO**



La guida del serraggio - **ATTREZZATURE MOTORIZZATE**

			COPPIE DI SERRAGGIO(N.m)																														
Alimentazione e tipologia	CODICE/MODELLO		0 10	10 20	20 30	30 40	40 50	50 70	70 90	90 200	200 300	300 400	400 500	500 600	600 700	700 800	800 900	900 1.000	1.000 2.000	2.000 3.000	3.000 4.000	4.000 5.000	5.000 6.000	6.000 7.000	7.000 8.000	8.000 10.000	10.000 20.000	20.000 40.000	40.000 60.000	60.000 80.000	80.000 100.000	100.000 200.000	200.000 300.000
A BATTERIA	A FRIZIONE	PISTOLA TSC	0,8 - 12 N.m																														
		ANGOLARI TWB	3 - 90 N.m																														
	A IMPULSI	TPA	5 - 65 N.m																														
	CON BRACCIO DI REAZIONE	TTB	34 - 950 N.m																														
		EBT	200 - 4.000 N.m																														
PNEUMATICI	A IMPULSI	A PISTOLA attacco quadro o con porta inserti esagonale 1/4"	5,5 - 450 N.m																														
		DRITTI attacco quadro o con porta inserti esagonale 1/4"	5,5 - 70 N.m																														
		ANGOLARE attacco quadro o con porta inserti esagonale 1/4"	8,5 - 70 N.m																														
	CON BRACCIO DI REAZIONE	PTM AD ALTA VELOCITÀ	100 - 6.000 N.m																														
		PTS	100 - 7.000 N.m																														
		CON ELETTRONICA A BORDO	100 - 2.000 N.m																														
		STANDARD	160 - 300.000 N.m																														
ELETRICI		EVOTORQUE	200 - 7.000 N.m																														
		STONE	150 - 10.000 N.m																														
CHIAVI IDRAULICHE		ATTACCO QUADRO TTX	228 - 40.200 N.m																														
		ATTACCO QUADRO TTS	167 - 50.300 N.m																														
		ESAGONO PASSANTE TTZ	351 - 49.080 N.m																														
		ESAGONO PASSANTE TTL	329 - 81.000 N.m																														

La guida del serraggio - **ATTREZZATURE MANUALI**

Alimentazione e tipologia	CODICE/MODELLO	COPPIE DI SERRAGGIO(N.m)	COPPIE DI SERRAGGIO(N.m)																													
			0 10	10 20	20 30	30 40	40 50	50 70	70 90	90 200	200 300	300 400	400 500	500 600	600 700	700 800	800 900	900 1.000	1.000 2.000	2.000 3.000	3.000 4.000	4.000 5.000	5.000 6.000	6.000 7.000	7.000 8.000	8.000 10.000	10.000 20.000	20.000 40.000	40.000 60.000	60.000 80.000	80.000 100.000	100.000 200.000
CACCANTI <small>(torques keys)</small>	TT		0,3 - 6 N.m																													
CHIAVI DINAMOMETRICHE MANUALI	TT		4 - 50 N.m																													
	PROFESSIONAL 15-400		10 - 400 N.m																													
	PROFESSIONAL 650-1500		130 - 1.500 N.m																													
	NORTORQUE		12 - 340 N.m																													
	CLICKTRONIC		10 - 340 N.m																													
	INDUSTRIAL PER VEICOLI COMMERCIALI		70 - 250 N.m																													
	INDUSTRIAL		100 - 2.000 N.m																													
	SLIMLINE		1 - 20 N.m																													
	PER ELETTRIDI		312 - 3.200 N.m																													
	CHIAVI DINAMOMETRICHE ELETTRONICHE	NORTRONIC		5 - 770 N.m																												
UVITEK			5 - 350 N.m																													
MOLTIPLICATORI DI COPPIA	HT3 - HT4		100 - 4.500 N.m																													
	COMPATTI		100 - 7.000 N.m																													
	DIAMETRO RIDOTTO		300 - 6.000 N.m																													
	STANDARD		100 - 47.500 N.m																													



Via Busoni n. 7/A - 20137 Milano
Tel +39 025516084
Fax +39 0254100448
uvit.it - staffuvit@uvit.it
Skype: uvitilcingolo

